

ANTENNA MAX

Maximum Flexibility, Maximum Gain
Outdoor Cellular / GPS Antenna + Enclosure



Maximum Gain: Up to 6.6dBi

Worried about cable loss?

Minimize cable loss by installing your router directly into the antenna enclosure.

Retain maximum signal gain by connecting the Antenna Max to the rest of your network with an ethernet cable.

Achieve Near 0dB cable loss

by eliminating RF cables from your setup.

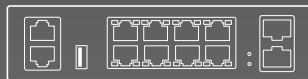

Switch

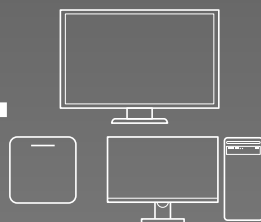

Client devices

5m RF cable 5dB+ cable loss

A 5m RF cable could lead to nearly complete signal loss on higher frequencies (2100MHz+)

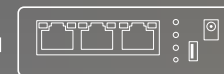

Router

Conventional Antenna



Maximum Durability

UV-resistant plastic enclosure resists moisture, water intrusion, salt spray and corrosion.



Maximum Flexibility

Mix-and-match the antenna with many routers including:

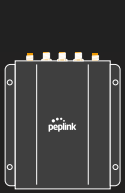

BR1 Mini Series ¹



Transit Duo Pro ³

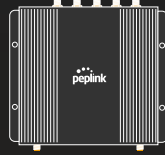

BR1 Pro 5G ³ / CAT20 ³

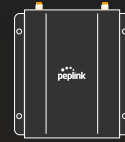

Adapter Series ^{2,3}



AP One Rugged

¹ BR1 Mini series: BR1 Mini, BR1 Mini Core, BR1 Mini 5G, BR1 Mini M2M.

² Adapter Series: POTS Adapter and MAX Adapter

³ For certain products which do not support PoE In, a PoE Splitter is required.

Fixed-roof L-mount set included

Mounts easily on mobile equipment and vehicles - trucks, vans, boats.



Deck Mount

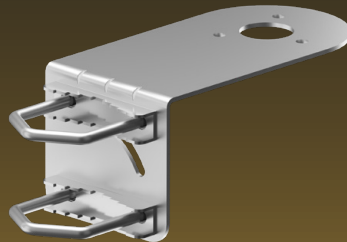

Pole Mount



Wall - Mount



Surface Mount

Maximum Value

Antenna Max is a **cost-effective way** to get maximum performance from your cellular and 5G routers in outdoor environments.

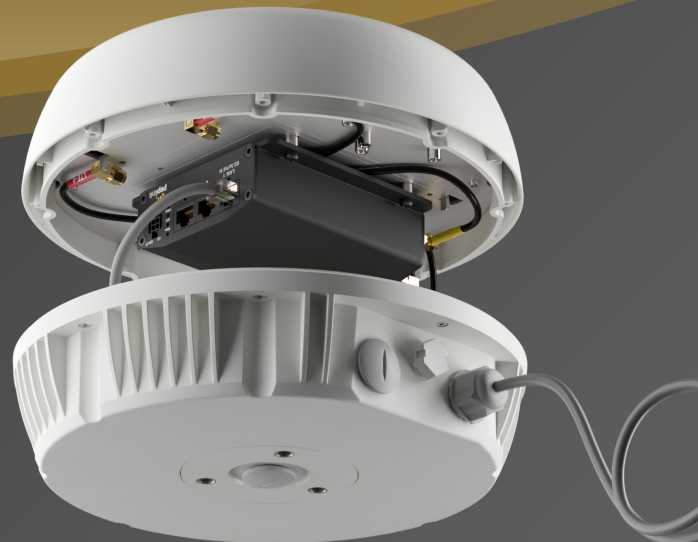

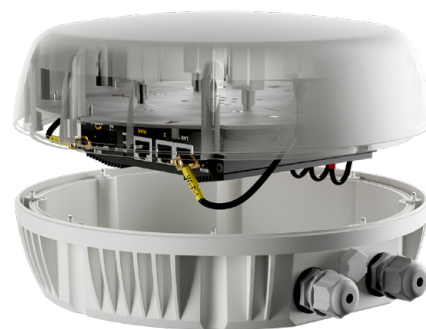

Specification

Cellular

Antenna Elements	4 elements
Peak Gain & Frequencies	3.0dBi: 617-960MHz 6.2dBi: 1410-2700MHz 5.7dBi: 3400-4400MHz 6.6dBi: 5000-6000MHz
VSWR	< 2.5 over 95% of the band
Feed Power Handling	10W
Input Impedance	50 Ω
Polarisation	Linear
Connectors	Right angle SMA male

Wi-Fi

Antenna Elements	2 elements
Peak Gain & Frequencies	5.4dBi: 2400-2500MHz 7.4dBi: 5000-6000MHz
VSWR	< 2.5
Feed Power Handling	10W
Input Impedance	50 Ω
Polarisation	Linear
Connectors	Right angle RP-SMA male

GPS

Frequency Range	1575-1602 MHz
Peak Gain	0.9dBi@1575MHz 0.8dBi@1602MHz
VSWR	< 2.0
Gain: LNA	27 \pm 3dB
Noise Figure	2.5dB
Operating Voltage	3.3V
Power Consumption	10 \pm 3.0mA
Connectors	Right angle SMA male

Specification

Mounting

Supported Types Surface, wall, pole

Mechanical

Product Dimensions 4.72" / 120 mm - Height
9.84" / 250 mm - Diameter

Package Contents

Package Contents Antenna MAX
L-Mount Set
Double sided 3M adhesive pad
3pcs Cable Gland
2pcs Hole Plug

Packaged Dimensions 13.82" x 11.61" x 5.75" 351x295x146mm

Enclosure Material UV stable PC

Environmental, Compliance

IP Rating IP67

Compliance ROHS, REACH, WEEE

Operating Temperature -40° - 176°F /
-40° - 80°C

Enclosure Flammability UL 94 V-0 (1.47 mm)

Storage Temperature -40° - 176°F /
-40° - 80°C

UV resistance UL 746C (F1 long-term UV exposure)

Salt Spray MIL-STD 810F/ASTM 8117

Ordering Information

Product Code

ANT-MAX

Description

4xLTE/5G, 2x Wi-Fi, 1xGPS 600-6000MHz, IP67, SMA male (Cellular, GPS), RP-SMA male (Wi-Fi), White

Antenna MAX

Technical Drawing

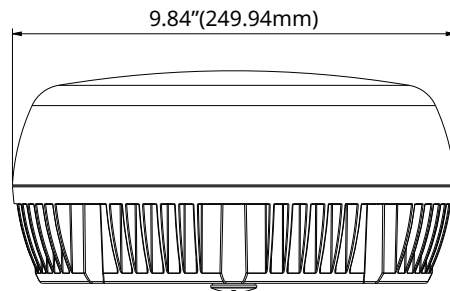
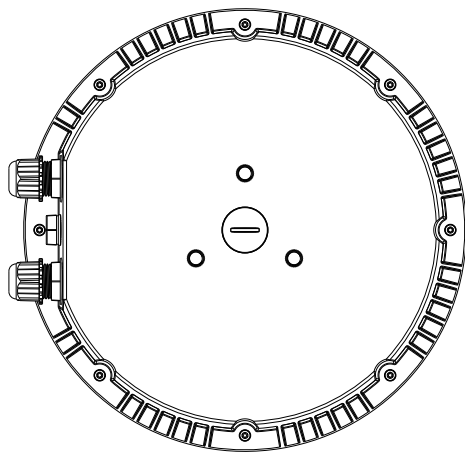
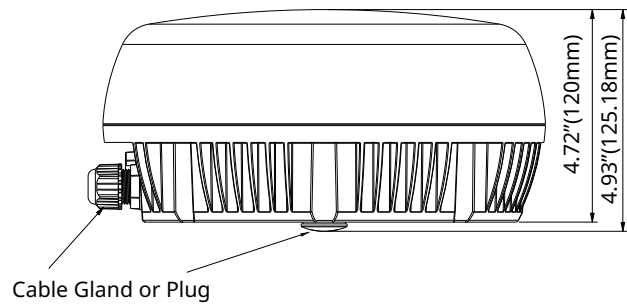
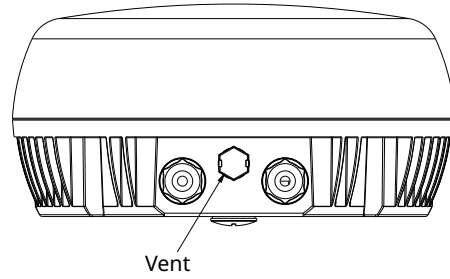
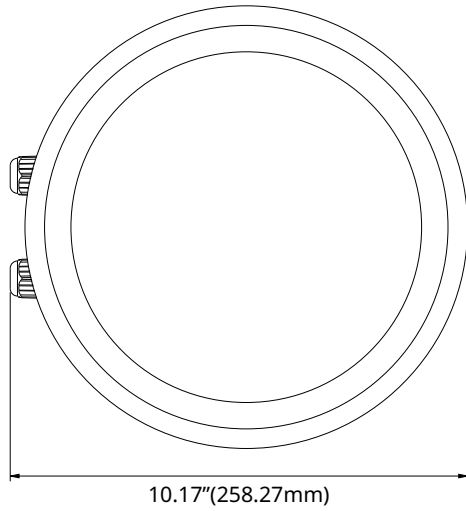

Cellular Antenna Performance

Cellular Antenna VSWR

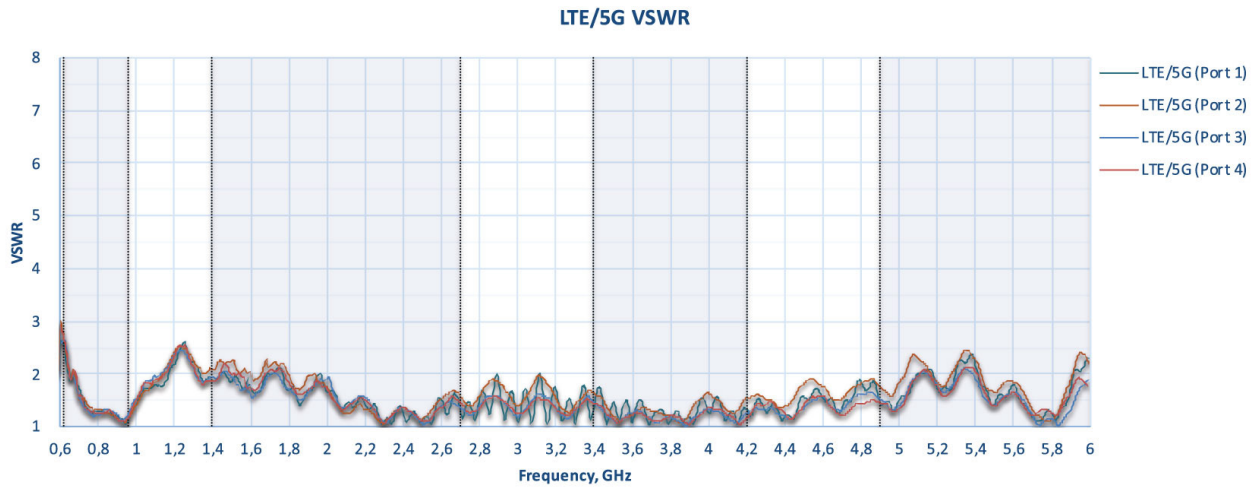

Cellular Antenna Gain

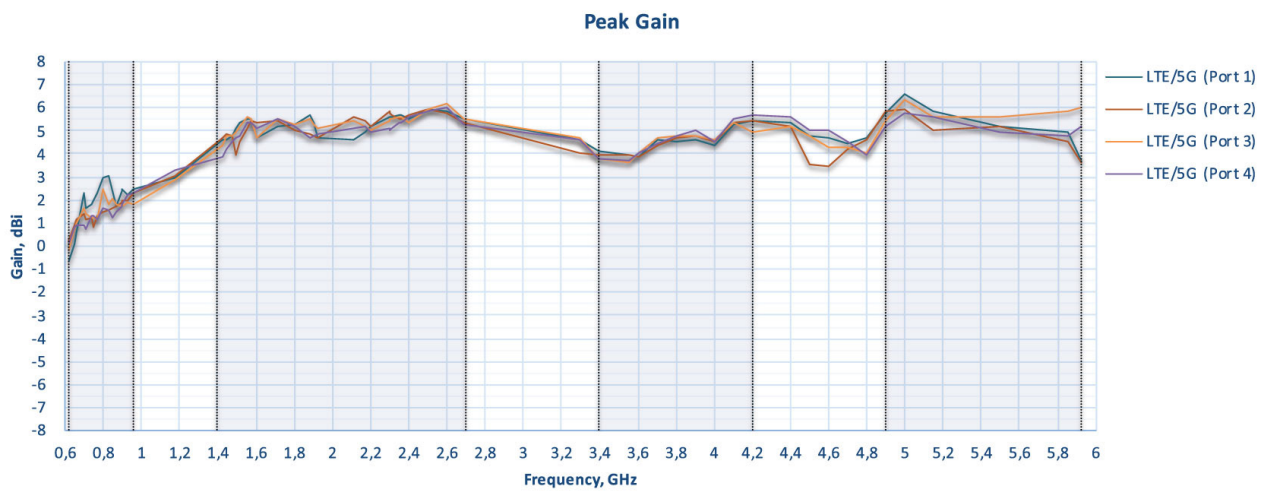

Cellular Antenna Efficiency

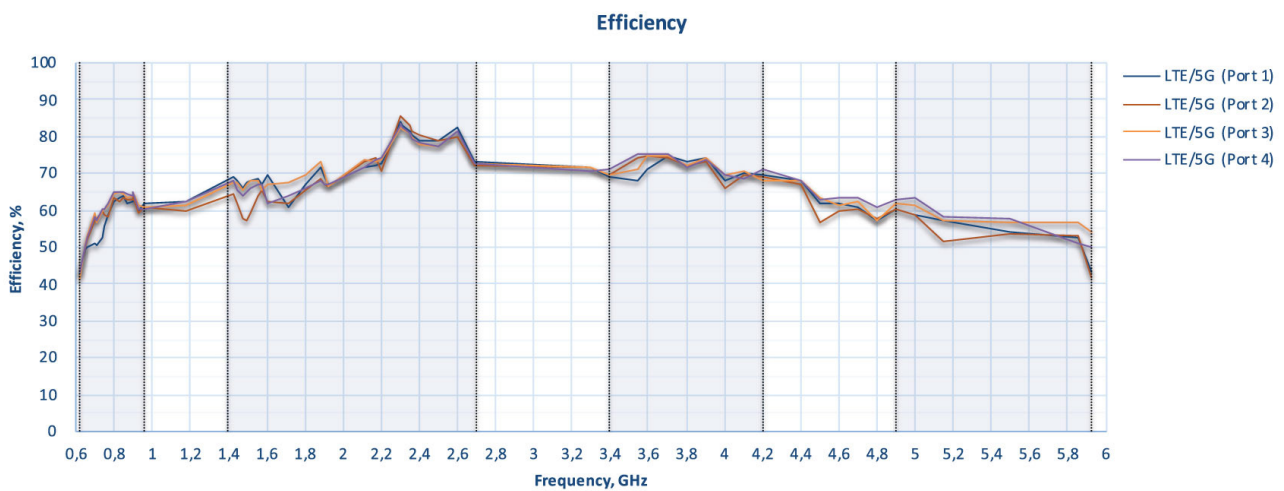

Wi-Fi Antenna Performance

Wi-Fi Antenna VSWR



Wi-Fi Antenna Gain

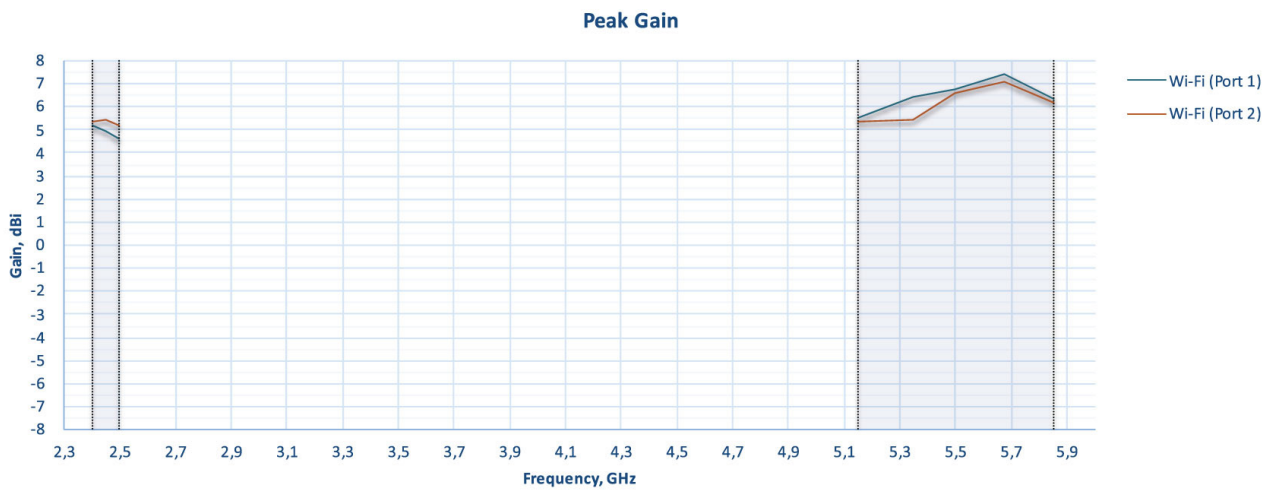

Wi-Fi Antenna Efficiency

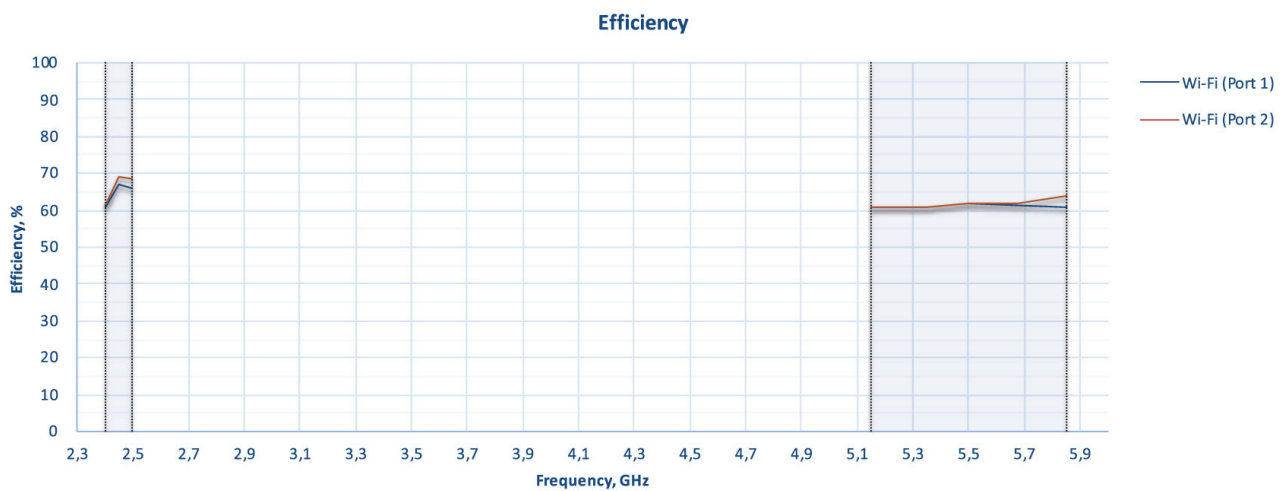

Cellular & Wi-Fi Antenna Performance

Cellular & Wi-Fi Antenna Isolation

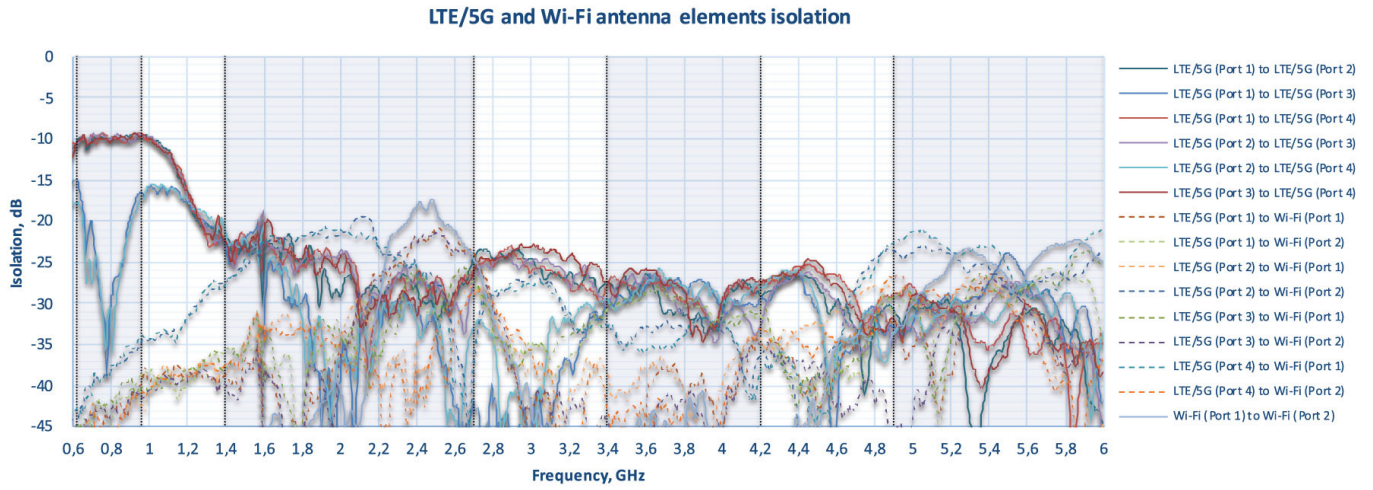

Radiation Pattern

LTE Radiation Patterns (Elevation 1)

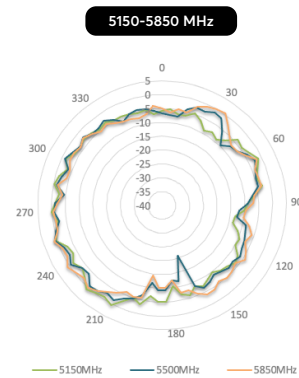
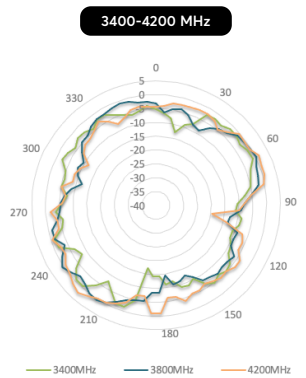
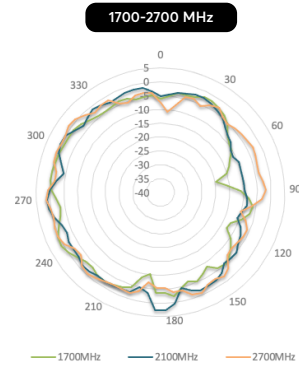
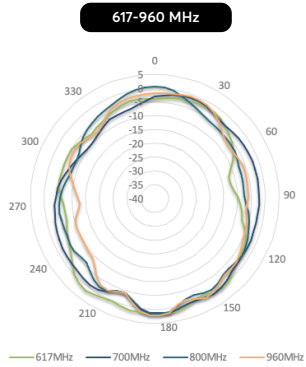

LTE Radiation Patterns (Elevation 2)

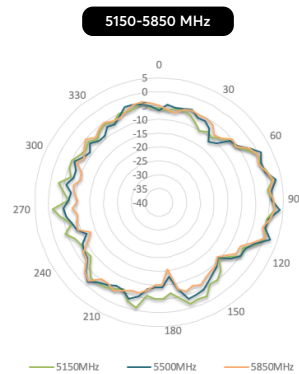
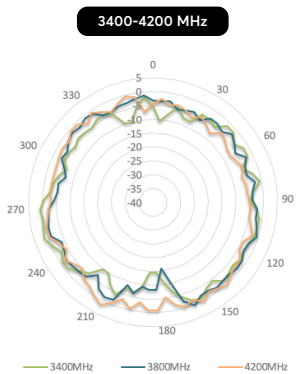
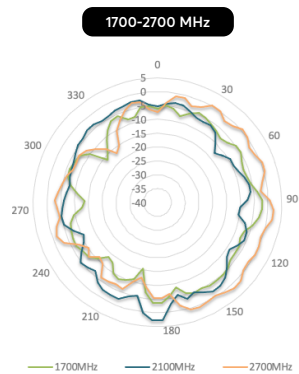
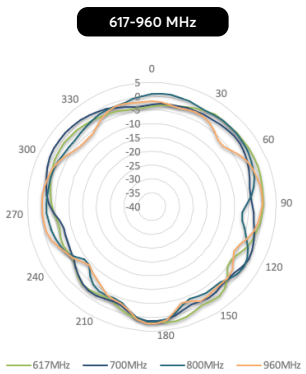

Radiation Pattern

Wi-Fi Radiation Patterns (Azimuth)

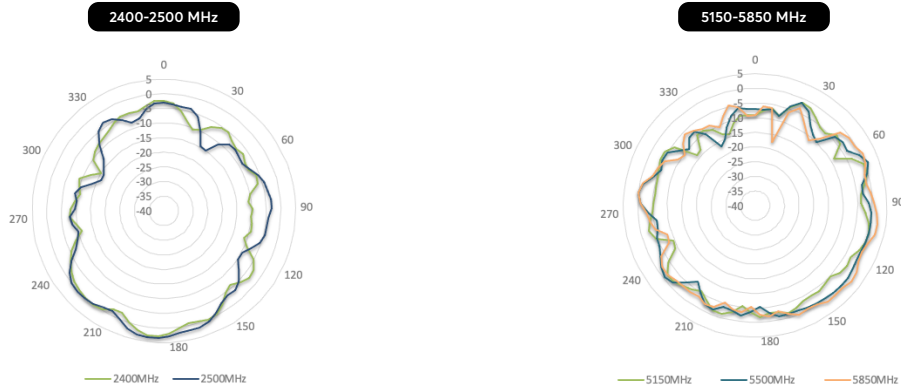

Wi-Fi Radiation Patterns (Elevation 1)

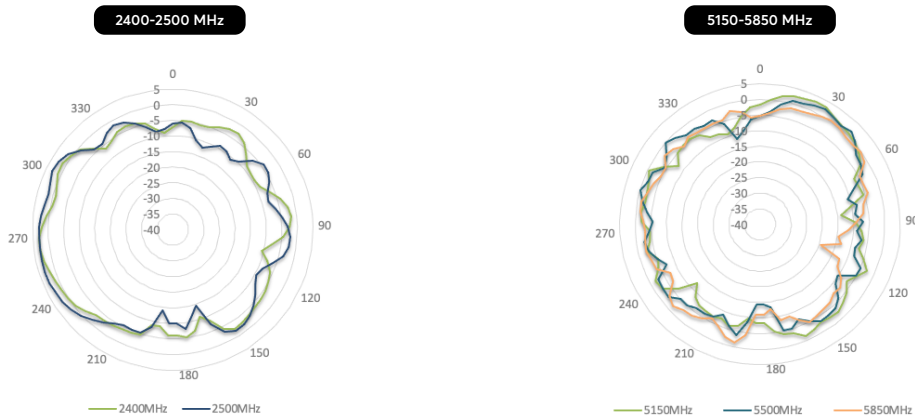

Wi-Fi Radiation Patterns (Elevation 2)

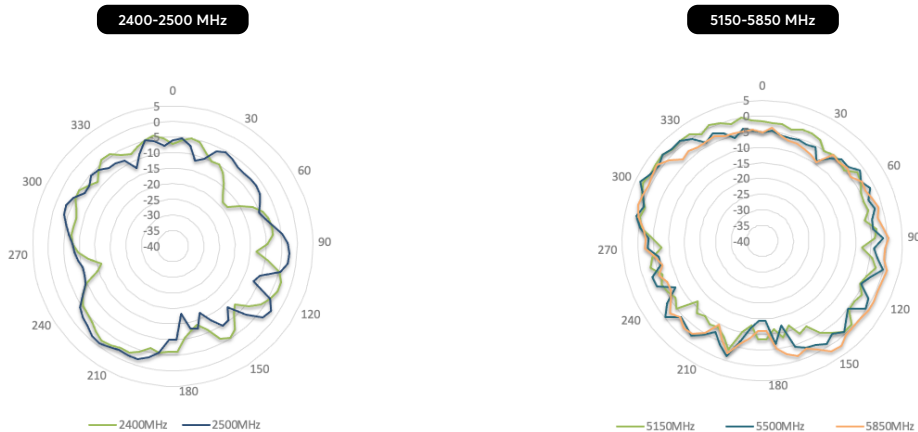

Installation Recommendation

Position Router

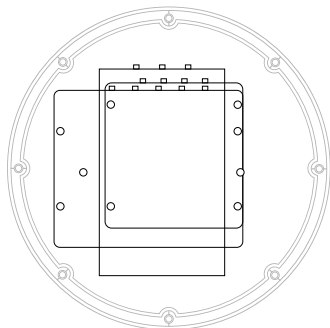

Make sure you align the router with the placement mark on the silkscreen.

Silkscreen

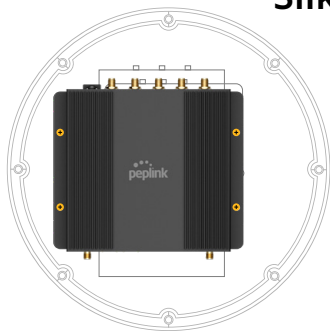

BR1 Pro 5G

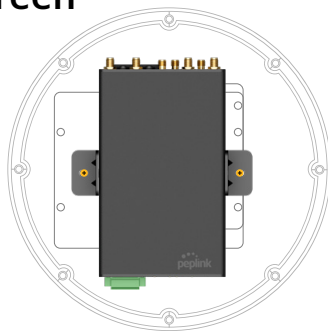

Transit Duo Pro

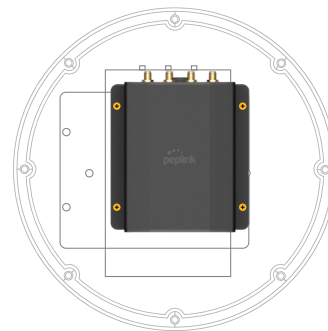

BR1 Mini Series

Install Router

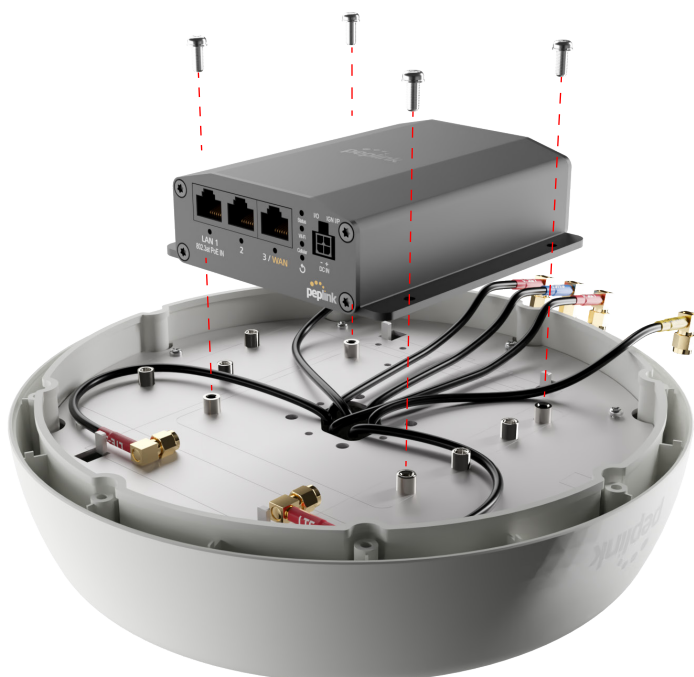

Tighten the screws securely into the corresponding router's mounting holes.



Installation Recommendation

Connect Cables to Router

Align the **Wi-Fi**, **LTE** and **GPS** SMA cables with the corresponding ports on the router. Tighten the connector into the port securely in place.



Ethernet Cable

Step 1

Use a cable stripper to remove the RJ45 connector and expose the individual wires.

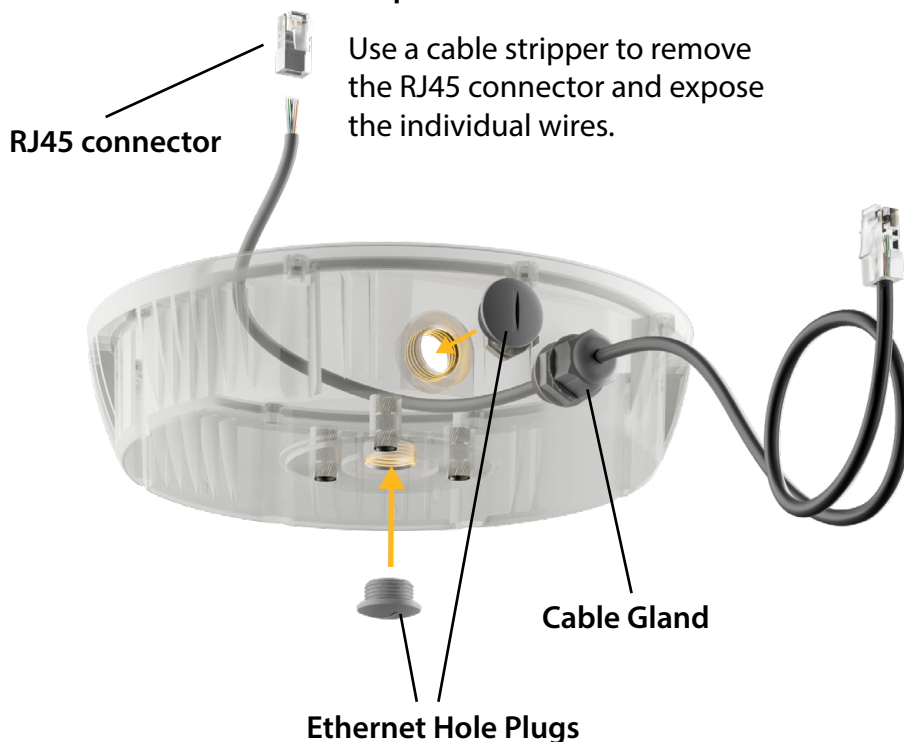

Step 2

Ethernet cable can be connected via the bottom or side cable gland on the device.

For any unused hole, use an **ethernet hole plug** to securely seal it.

Note: Be sure not to use excessive force when removing the connector as it is delicate.

Installation Recommendation

Attach Bottom Cover

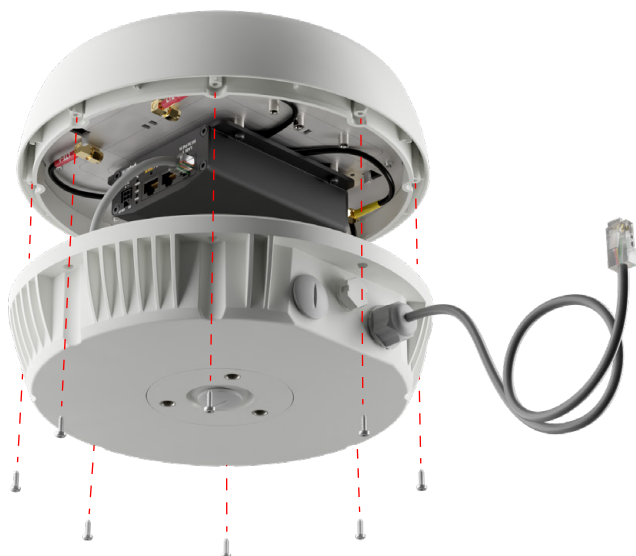

Align the bottom cover with the top cover, secure it in place, and then tighten the screws.

Install PoE Splitter

While some routers may not support Power over Ethernet (PoE) input, Peplink PoE splitter can be used to provide power to these devices.

Ethernet Data Input

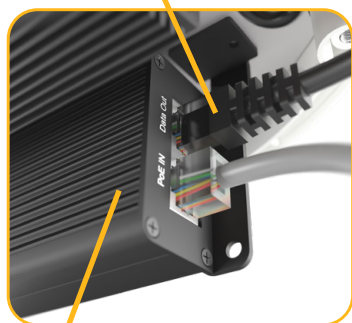

PoE Input

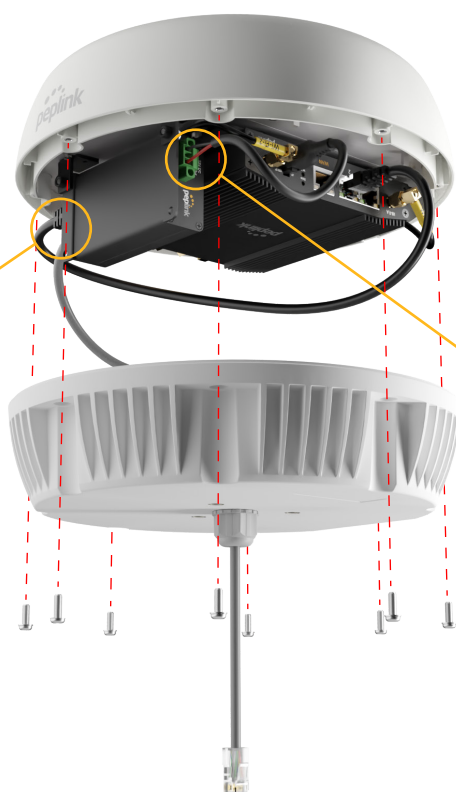

DC output to router

Installation Recommendation

Wall Mount



Pole Mount



Vertical Pole



Horizontal Pole

Installation Recommendation

Surface Mount



Deck Mount



Note: The deck mount kit is **NOT included** in the package.

Packing List Information

Antenna

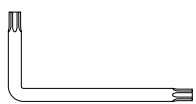
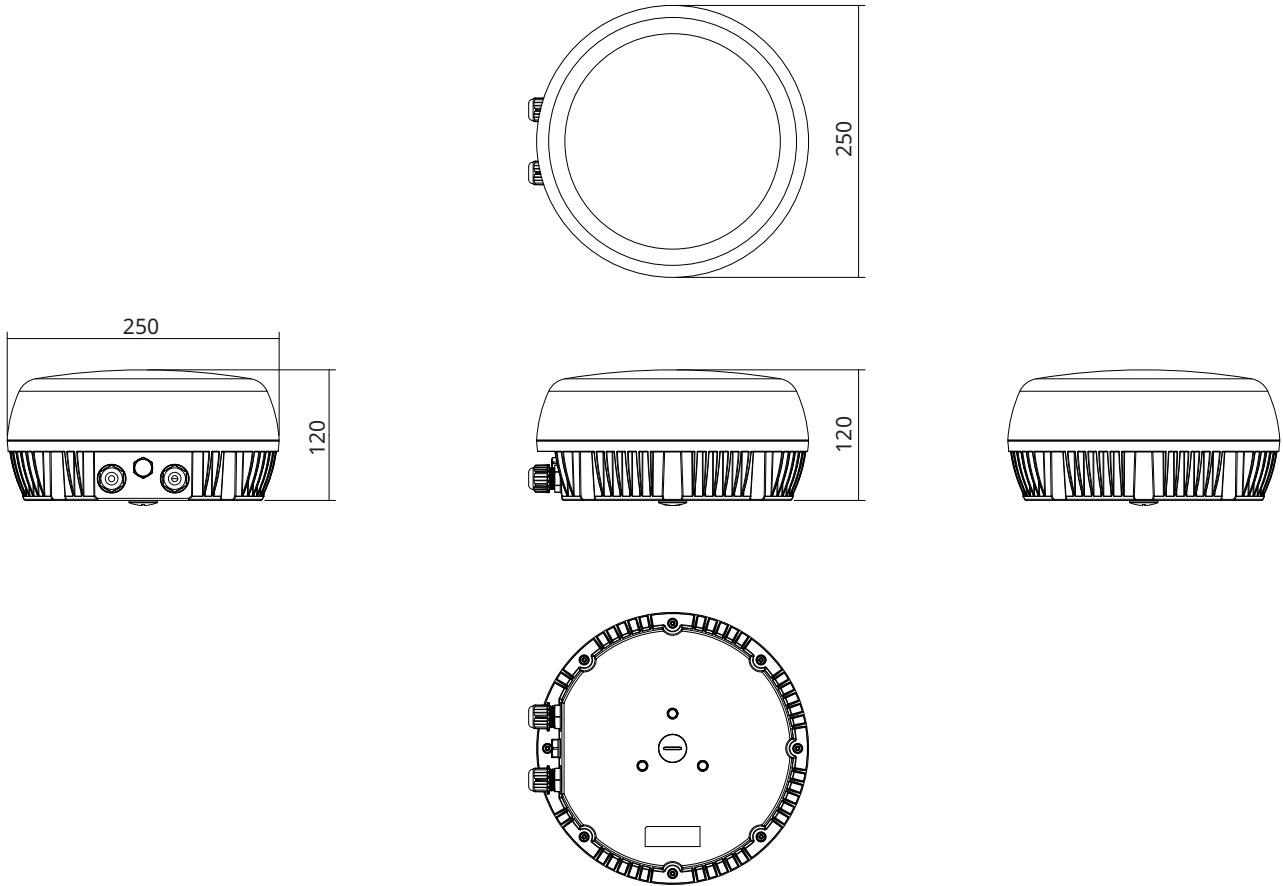

L-wrench for T20 bolts



Bolt
(4 pcs, T20 M4xL8)
Router



Bolt
(2 pcs, T20 M4xL8)
PoE



Bolt
(8 pcs, T20 M4xL12)
Cover

L-Mount Mount Set

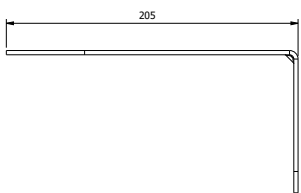

L-Mount

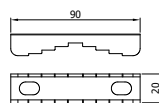
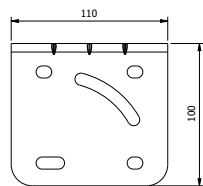

Bracket
(2 pcs)

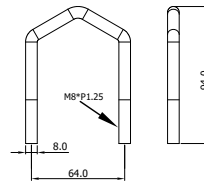

V-bolt
(2 pcs)



Hex Socket
(3pcs, H6, M8xL20)



V-bolt nut
(4 pcs, M8)