

WAVEHUNTER™

The Most Advanced and Fastest Cellular
Antenna for Seamless Connectivity



POYNTING

ANTENNAS | WAVEHUNTER SERIES

X-POLARISED, HIGH GAIN, MULTI-DIRECTIONAL 5G/LTE 24X24 MULTI MIMO ANTENNA ARRAY

617 – 960 MHz & 1710 – 4200 MHz, 11dBi, 6x (4x4 MIMO) + 4x4 MIMO Dual Band Wi-Fi + 2x2 GPS/Glonass

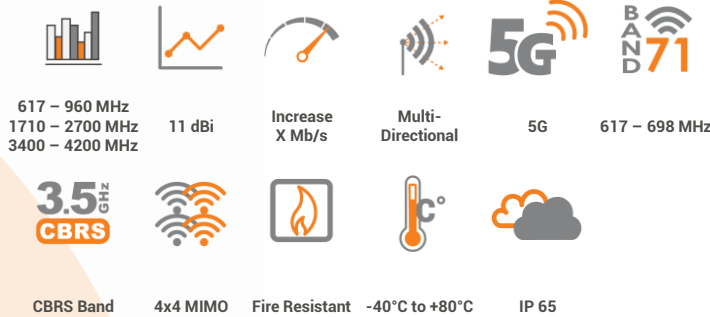

APPLICATION AREAS

- Antenna enclosure with high performance antennas
- New advanced metamaterial technology
- Exceptional high gain performance over the main 4G/5G bands
- Cross-polarised antennas for improved performance
- IP 65 weather/dust resistant enclosure

Product Overview

Poynting Antennas introduces its all-new antenna enclosure range, the WaveHunter™ series. The WaveHunter™ enclosure is designed to fit a variety of router and networking modules, transforming the antenna enclosure into a CPE (Customer Premises Equipment) – just add your own LTE/5G routers and networking equipment. The WaveHunter™ enclosure can accommodate two routers up to the size of 250 x 150 x 50 mm³ mounted directly to the base. Additional equipment can be added within a stacked customised user supplied frame. The WaveHunter™ antenna enclosure uses our world renowned Artificial Magnetic Conductor (AMC) technology from our XPOL-2-5G antenna. The antenna array consists of 12 cross-polarised, high gain, 2x2 MIMO directional antennas arranged in two stacked arrays offset at 60° increments. This provides 360° wideband coverage from 617 to 960 MHz and 1710 to 4200 MHz, with a peak gain of 11 dBi, making it ideal for Multi-router LTE & 5G bonded and aggregated deployments. The enclosure was also designed to withstand adverse weather condition, making the antenna weatherproof and waterproof with an IP 65 rating.

Features

- Ultra-wideband coverage from 617- 960 & 1710 - 4200 MHz
- High gain directional antennas, with a peak gain of 11 dBi
- Dual-band Wi-Fi
- Can accommodate up to 6 routers for optimal throughput
- Purpose built antenna for marine and coastal applications
- Weatherproof and water-resistant enclosure (IP 65)
- UV and saltwater resistant
- Aluminium heatsink base with excellent thermal properties for devices integrated within the WaveHunter™

Application Area

- Marine applications: Super yachts, commercial vessels, cruise ships, ferries, private yachts, and towing vessels
- Harsh environments such as harbour buildings, and buoys
- Enhanced LTE/4G and 5G reception
- Increase system transmission reliability



WAVEHUNTER

Frequency Band

The WAVEHUNTER is a circular array of uni-directional antennas that operates in the following frequency bands: | 617 – 960 MHz | 1710 – 2700 MHz | 3400 – 4200 MHz | as well as the Wi-Fi frequency bands | 2400 – 2500 MHz | and | 5000 – 7200 MHz |

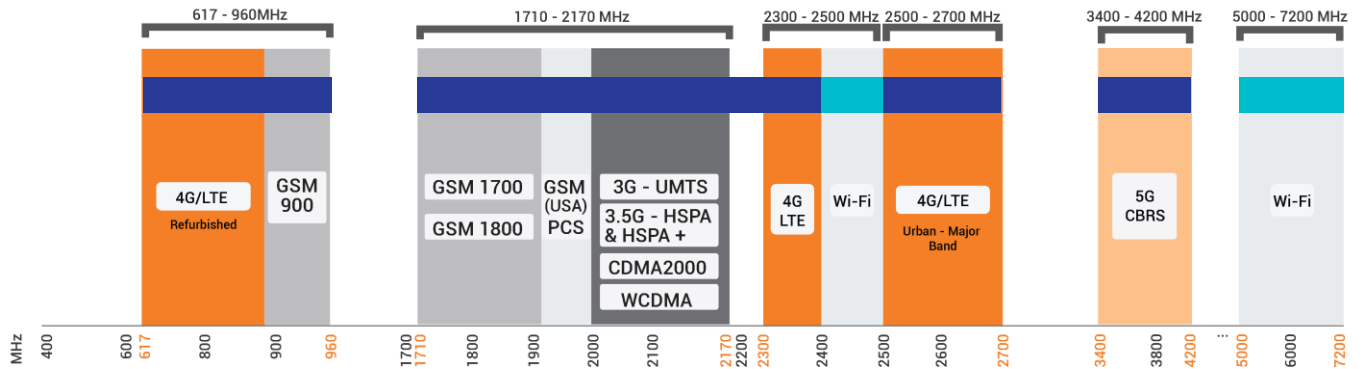

■ Indicates the 5G/LTE bands on which WAVEHUNTER works

■ Indicates the Wi-Fi bands on which WAVEHUNTER works

ANTENNA DERIVATIVES

Product Order Code (SKU)	A-WHUNTER-001-V3-101	A-WHUNTER-001-V3-102
Mounting Option	Use provided pedestal	No pedestal
Ports	LTE: Vertical Polarised (x 6), Horizontal Polarised (x 6), Slanted +45° (x 6) & Slanted -45° (x 6) Wi-Fi: Vertical Polarised (x 2) & Horizontal Polarised (x 2) GPS: Circular Polarised (x 2)	LTE: Vertical Polarised (x 6), Horizontal Polarised (x 6), Slanted +45° (x 6) & Slanted -45° (x 6) Wi-Fi: Vertical Polarised (x 2) & Horizontal Polarised (x 2) GPS: Circular Polarised (x 2)
SISO / MIMO	2x2 or 4x4 MIMO – LTE, 2 x (2x2 MIMO)– Wi-Fi & 2 x (SISO) - GPS	2x2 or 4x4 MIMO – LTE, 2 x (2x2 MIMO)– Wi-Fi & 2 x (SISO) - GPS
Frequency Bands	617 – 4200 MHz – LTE, 2.4-2.5 GHz & 5 – 7.2 GHz – Wi-Fi & 1575.42 MHz / 1600 MHz - GPS	617 – 4200 MHz – LTE, 2.4-2.5 GHz & 5 – 7.2 GHz – Wi-Fi & 1575.42 MHz / 1600 MHz - GPS
Polarisation	Vertical, Horizontal & ±45° - LTE, Linear – Wi-Fi & Circular - GPS	Vertical, Horizontal & ±45° - LTE, Linear – Wi-Fi & Circular - GPS
Peak Gain	11 dBi – LTE, 7.5 dBi – Wi-Fi & 21 dBi - GPS	11 dBi – LTE, 7.5 dBi – Wi-Fi & 21 dBi - GPS
Coax Cable Type	RG141 – LTE, Wi-Fi & GPS	RG141 – LTE, Wi-Fi & GPS
Coax Cable Length	750mm – LTE, Wi-Fi & GPS	750mm – LTE, Wi-Fi & GPS
Connector Type	24 x SMA (M) – LTE, 4 x RP- SMA (M) – Wi-Fi & 2 x SMA (M) - GPS	24 x SMA (M) – LTE, 4 x RP- SMA (M) – Wi-Fi & 2 x SMA (M) - GPS
Weight	61.54 kg	52.78 kg
Packaged Weight	97.06 kg	82.58 kg
Antenna Dimensions (L x W x H)	652 mm x 652 mm x 888 mm	652 mm x 652 mm x 750 mm
Packaged Dimensions (L x W x H)	700 mm x 700 mm x 940 mm	695 mm x 695 mm x 940 mm
EAN	6009710926390	6009710926413

*The coax cables & connectors are factory mounted to the antenna

Electrical Specifications - Cellular

Frequency Bands:	617 – 960 MHz 1710 – 2700 MHz 3400 – 4200 MHz
Gain (Max):	11 dBi
VSWR:	<2.5:1 Over 90% of the band
Feed Power Handling:	10 W
Input Impedance:	50 Ohm (nominal)
Polarisation:	Vertical, Horizontal & ±45°
Coax Cable Loss:	0.479 dB/m @ 900 MHz 0.695 dB/m @ 1800 MHz 0.943 dB/m @ 3000 MHz
DC Short:	Yes

Electrical Specifications - GPS/Glonass Antenna

Frequency Range (GPS):	1575.42MHz/1600MHz
Gain (Max):	21+/-2dBi
VSWR:	≤1.5:1
DC Voltage:	2.7-3.3 V
DC Current:	5-15mA
Noise Figure:	≤1.5 dB
Nominal Impedance:	50 Ω
Polarisation:	RHCP
Filter Out Band Attenuation:	12dB Min f0+50MHz, 16dBi Min f0-50MHz
Voltage:	2.7 - 3.3V
Coax Cable Loss:	0.586 dB/m @ 1500 MHz
Max. Power-W:	50W

Electrical Specifications – Wi-Fi

Frequency:	2400-2500 MHz 5000-7200 MHz
Gain (Max) Port 1 & 2:	5 dBi @ 2400-2500 MHz 7.5 dBi @ 5000-7200 MHz
VSWR Port 1 & 2:	≤2:1 over 95% of the band
Feed power Handling:	10 W
Nominal Input Impedance:	50 Ohm (nominal)
Polarisation:	Linear Vertical
Coax Cable Loss:	0.821 dB/m @ 2400 MHz 1.42 dB/m @ 5800 MHz
Path to Ground:	Yes

Product Box Contents

Antenna:	A-WHUNTER-001-V3
Mounting Bracket:	See Mounting Options

Mechanical Specifications

Packaged Type:	ClipLok™ Padded Container
Radome Material:	UV Stable E-Glass
Radome Colour:	Brilliant White Pantone P 179-1 C
Mounting Type:	See Mounting Options

Environmental Specifications, Certification & Approvals

Wind Survival:	≤186 km/h
Temperature Range (Operating, Antenna Array only):	-40°C to +80°C
Environmental Conditions:	Outdoor
Water Ingress Protection Ratio/Standard:	IP 65
Salt Spray:	MIL-STD 810G/ASTM B117
Operating Relative Humidity:	Up to 98%
Storage Humidity:	5% to 95% - non-condensing
Storage Temperature:	-40°C to +80°C
Enclosure Flammability Rating:	UL 94-HB
Impact Resistance:	IK 08
Product Safety & Environmental:	Complies with CE and RoHS Standards



Antenna Performance Plots

VSWR: Cellular Antenna

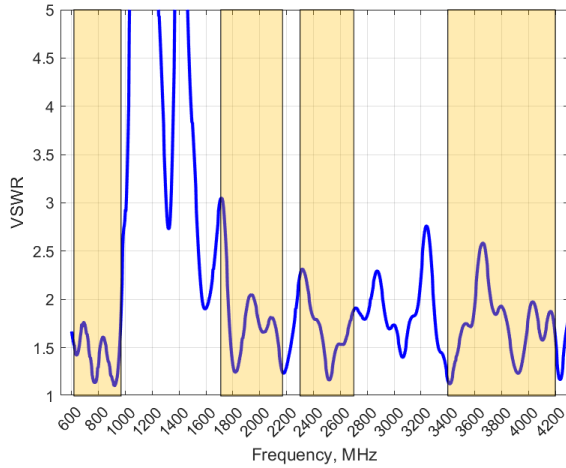

Voltage Standing Wave Ratio (VSWR)*

VSWR is a measure of how efficiently radio-frequency power is transmitted from a power source, through a transmission line, into a load. In an ideal system, 100% of the energy is transmitted which corresponds to a VSWR of 1:1.

The WAVEHUNTER delivers superior performance across all bands with a VSWR of 2.5:1 or better across 90% of the bands.

*VSWR measured without a cable.

VSWR: Wi-Fi Antenna

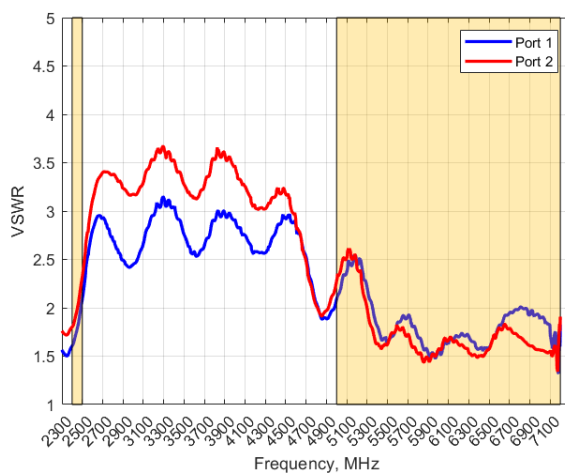

Voltage Standing Wave Ratio (VSWR)*

VSWR is a measure of how efficiently radio-frequency power is transmitted from a power source, through a transmission line, into a load. In an ideal system, 100% of the energy is transmitted which corresponds to a VSWR of 1:1.

The PUCK delivers superior performance across all bands with a VSWR of $\leq 2:1$ across 95% of the bands.

*Measured with 2m low loss cable, 650 x 650 mm ground plane, and unused ports terminated with 50Ω load.

GAIN (Excluding Cable Loss): Cellular Antenna

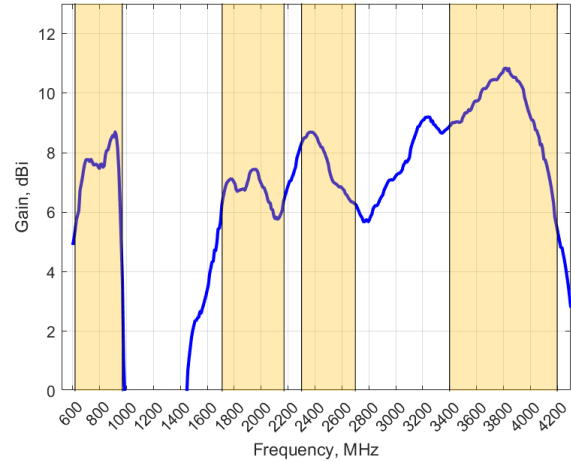

Gain* in dBi

11 dBi is the peak gain across all bands from 617 – 4200 MHz

Gain @ 617 – 960 MHz: 9 dBi

Gain @ 1710 – 2700 MHz: 9 dBi

Gain @ 3400 – 4200 MHz : 11 dBi

*Antenna gain measured with polarisation aligned standard antenna

GAIN (Excluding Cable Loss): Wi-Fi Antenna

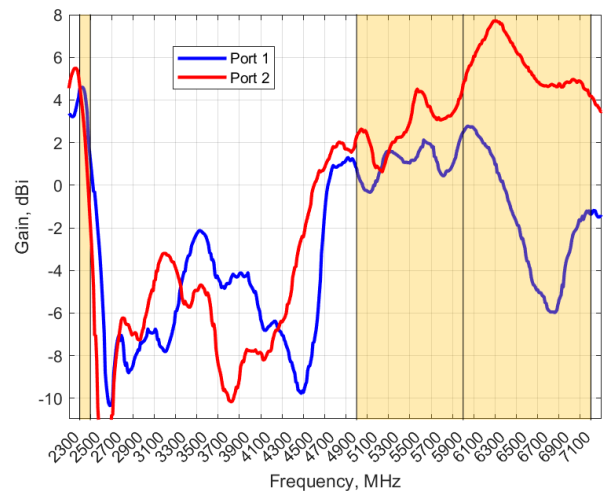

Gain* in dBi

7.5 dBi is the peak gain across all bands from 2400 – 2500 MHz & 5000 – 7200 MHz

Gain @ 2400 – 2500 MHz: 5 dBi

Gain @ 5000 – 7200 MHz: 7.5 dBi

*Antenna gain measured with polarisation aligned standard antenna

Radiation Patterns - Cellular

Azimuth: 617 – 960 MHz

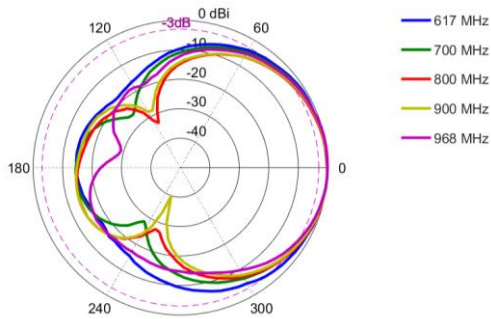

Azimuth: 1710 – 2170 MHz

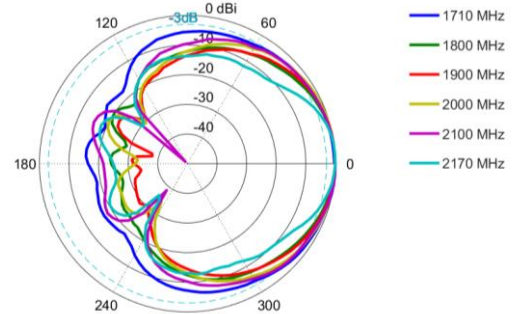

Azimuth: 2300 – 2700 MHz

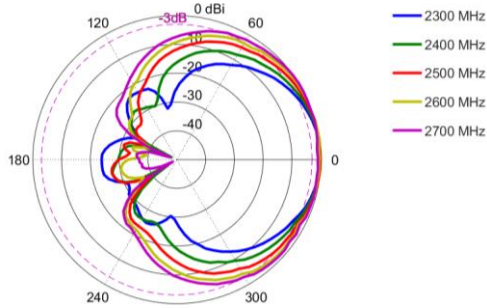

Azimuth: 3400 – 4200 MHz

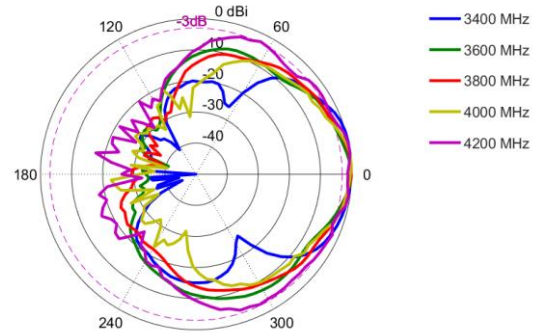

Elevation: 617 – 960 MHz

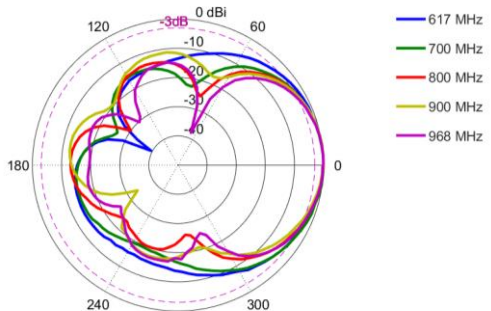

Elevation: 1710 – 2170 MHz

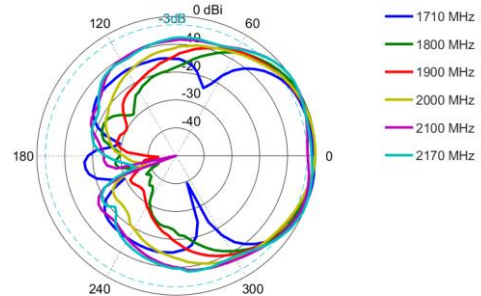

Elevation: 2300 – 2700 MHz

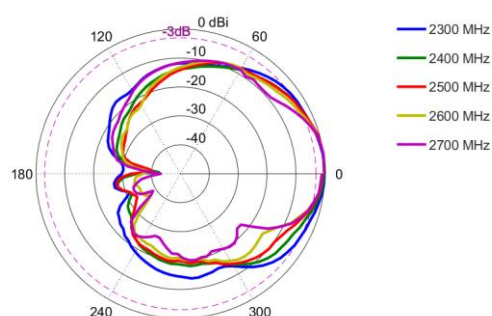

Elevation: 3400 – 4200 MHz

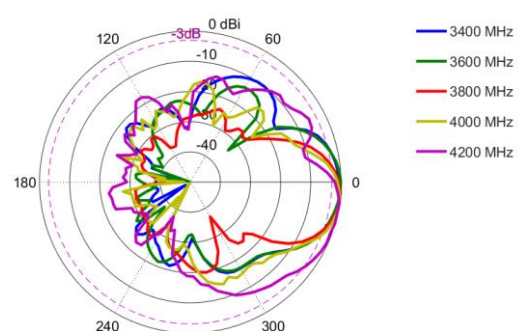

*Radiation Patterns illustrated are for a single antenna element out of the 24 antenna elements that are inside

Radiation Patterns – Wi-Fi

Azimuth: 2400 – 2500 MHz

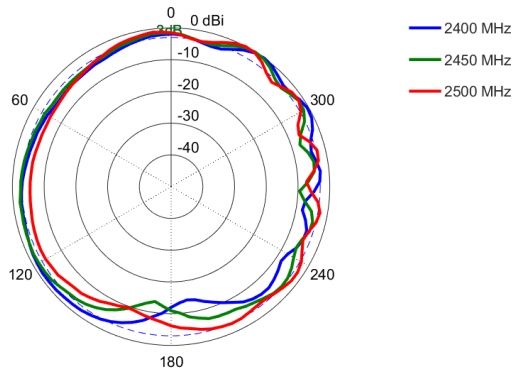

Azimuth: 5000 – 5400 MHz

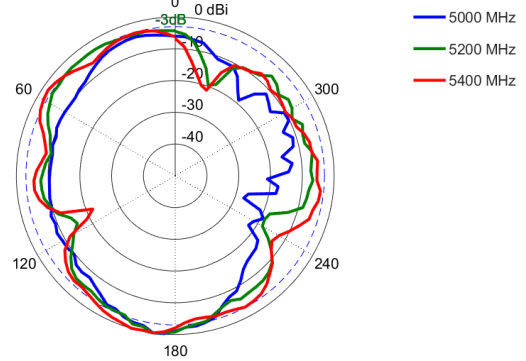

Azimuth: 5600 – 5800 MHz

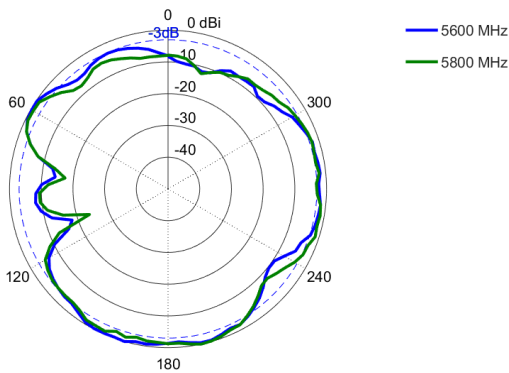

Azimuth: 6000 – 7200 MHz

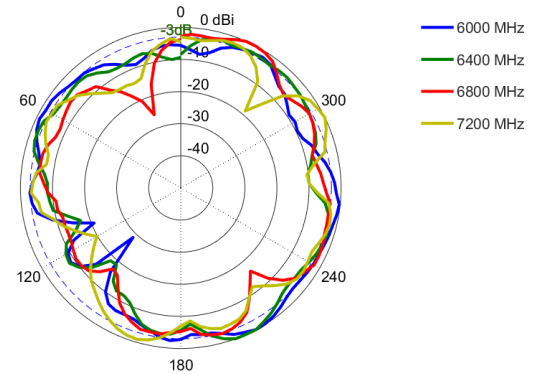

Elevation 1: 2400 – 2500 MHz

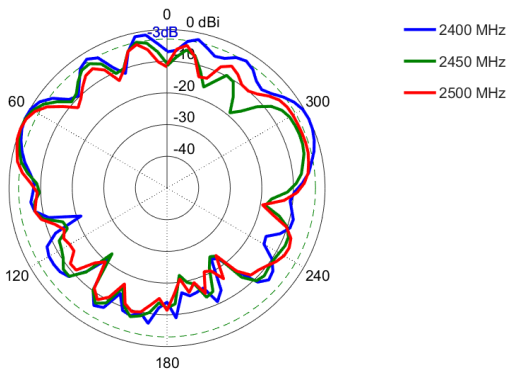

Elevation 1: 5000 – 5400 MHz

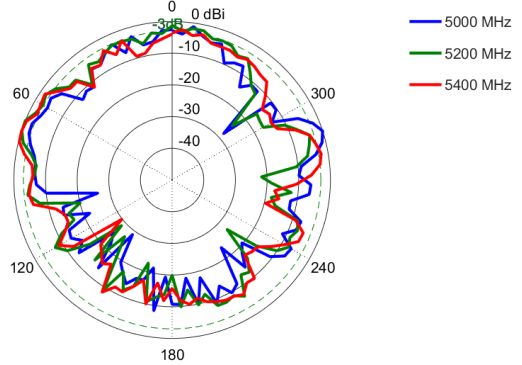

Elevation 1: 5600 – 5800 MHz

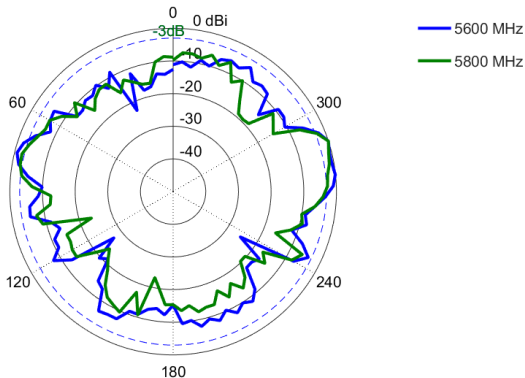

Elevation 1: 6000 – 7200 MHz

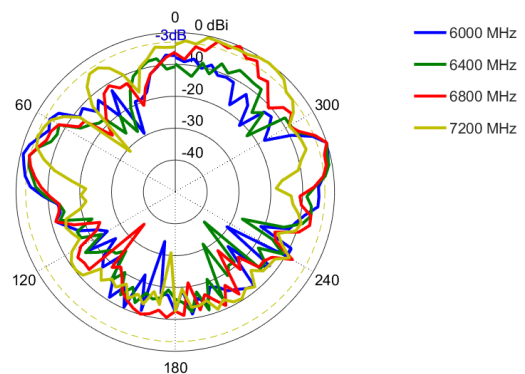

Elevation 2: 2400 – 2500 MHz

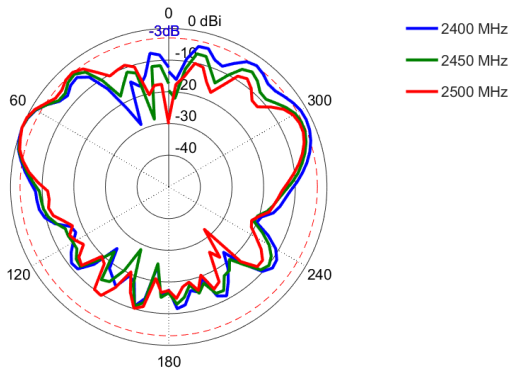

Elevation 2: 5000 – 5400 MHz

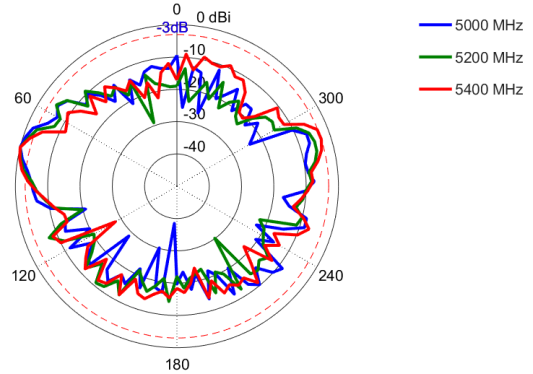

Elevation 2: 5600 – 5800 MHz

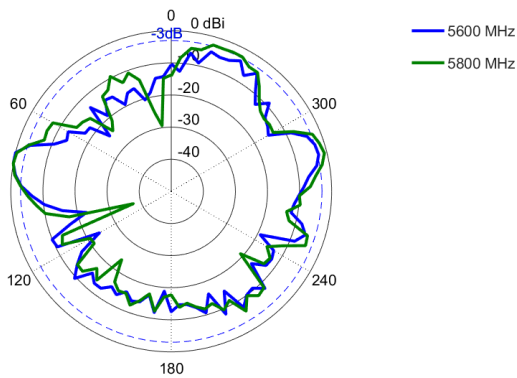

Elevation 2: 6000 – 7200 MHz

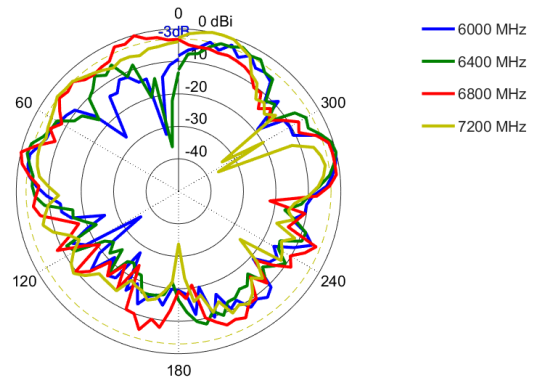

Radiation Patterns – GPS

XY Plane: 1561–1602 MHz

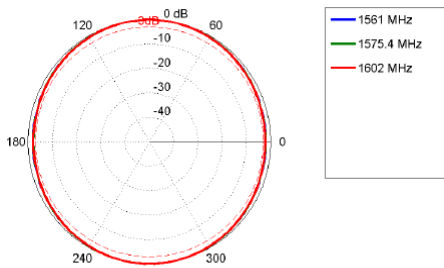

XZ Plane: 1561–1602 MHz

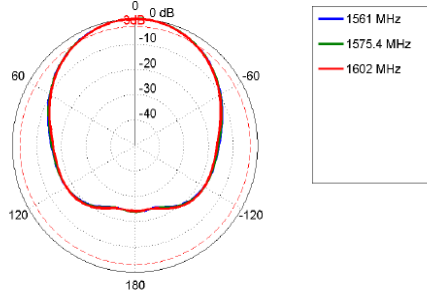

YZ Plane: 1561–1602 MHz

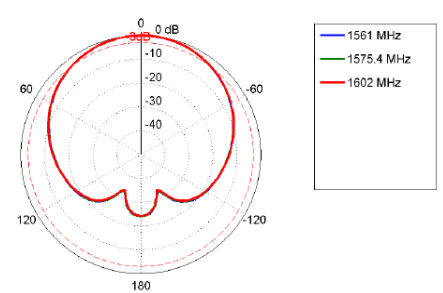

Radiation Patterns – Multi-Directional

Radiation Pattern below indicating the Multi-Directional overlapping patterns created by the array, which depicts the high gain 360° coverage. Pattern denotes combined H / V and $\pm 45^\circ$ beamwidth, hence 12 patterns only. The below for illustrative purposes only.

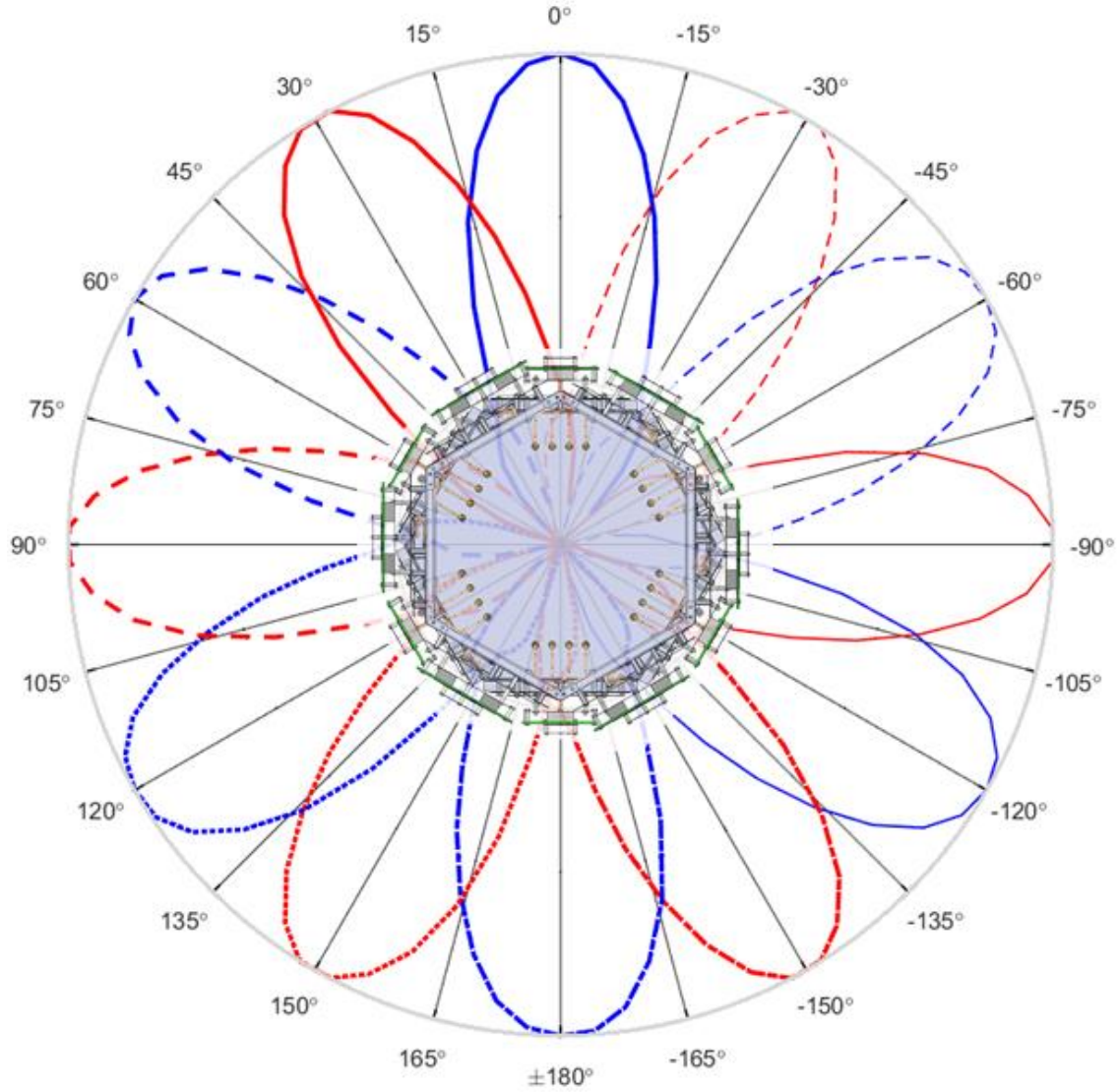

Technical Drawings

A-WHUNTER-001-V3-101 – Pedestal Mount

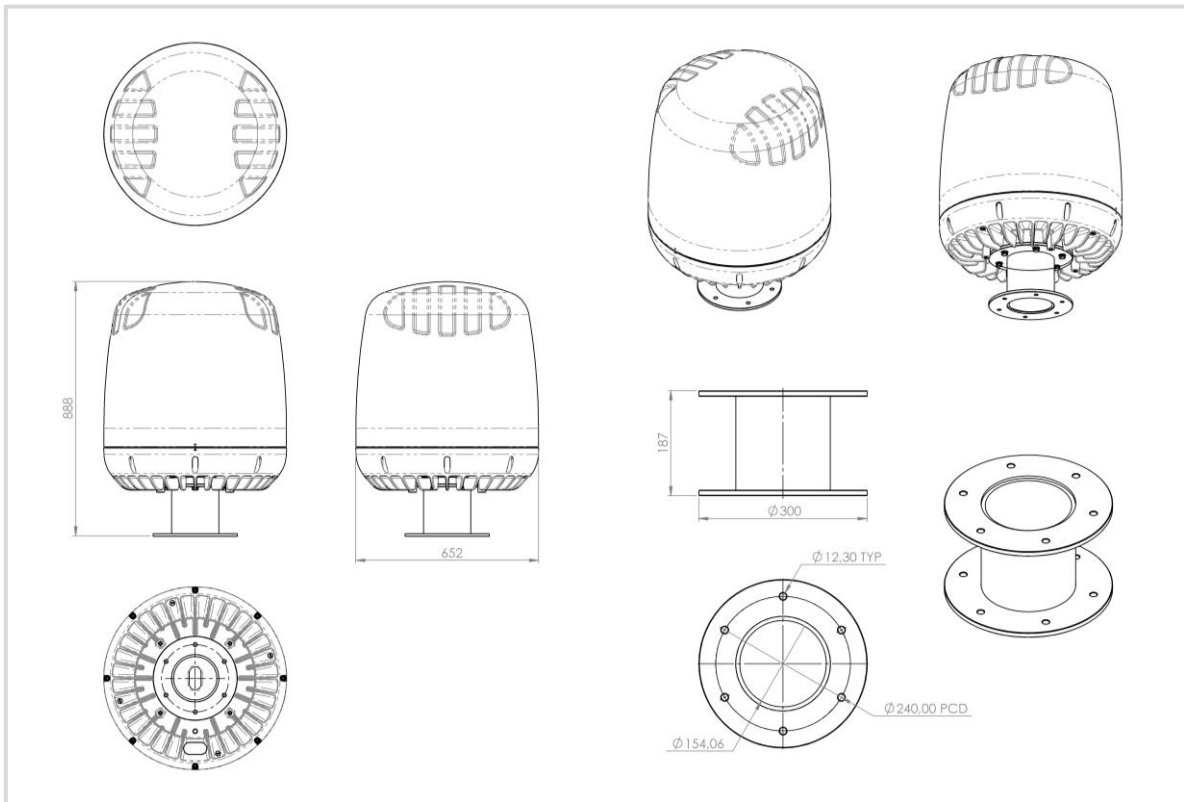

A-WHUNTER-001-V3-102 – Base Mount

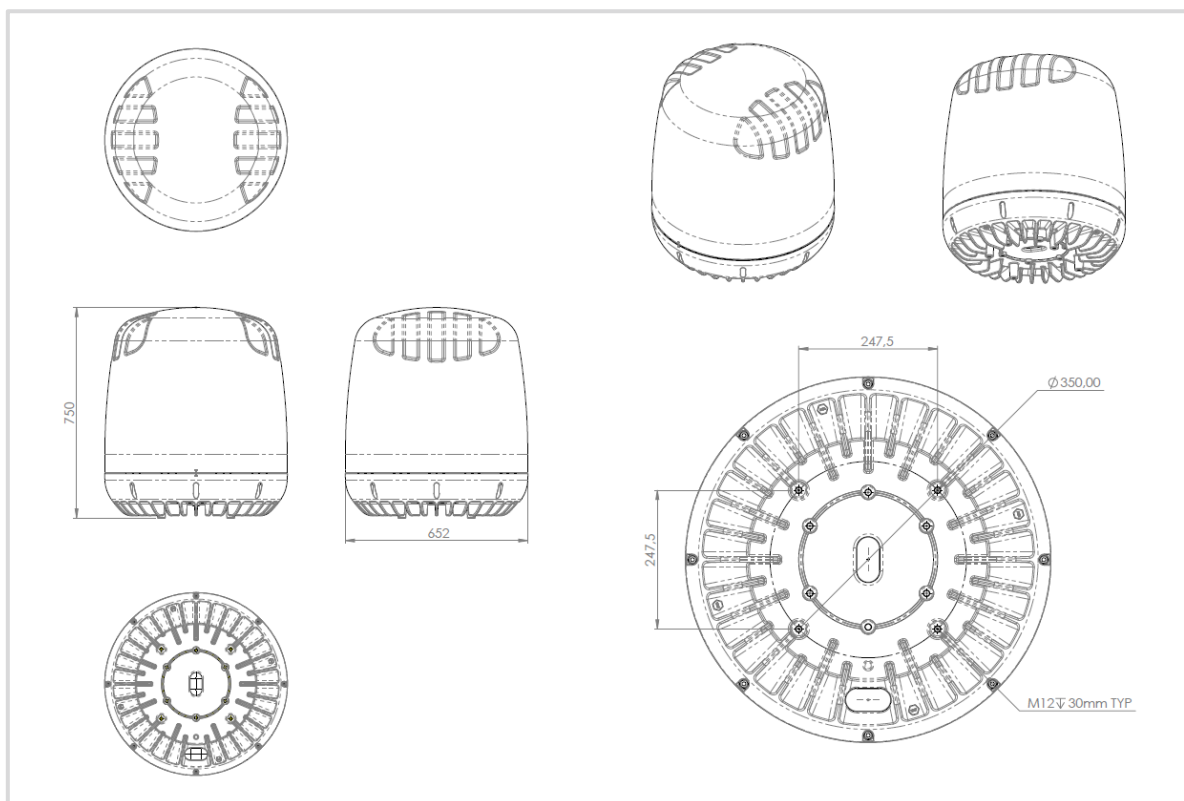

Product Packaging

The WaveHunter will be packaged in a standard ClipLok™ Padded Container for added protection. The ClipLok™ size will depend on the mounting options and will be as follows:

A-WHUNTER-001-V3-101: Pedestal Mount

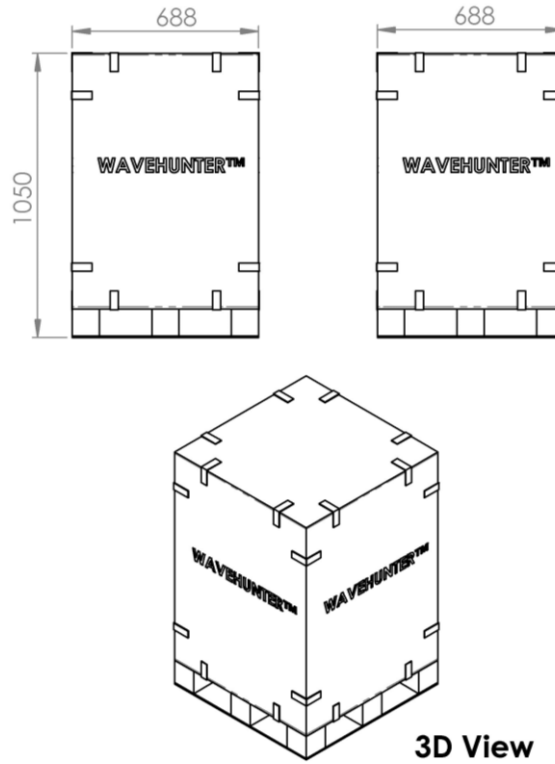

A-WHUNTER-001-V3-102: Base Mount

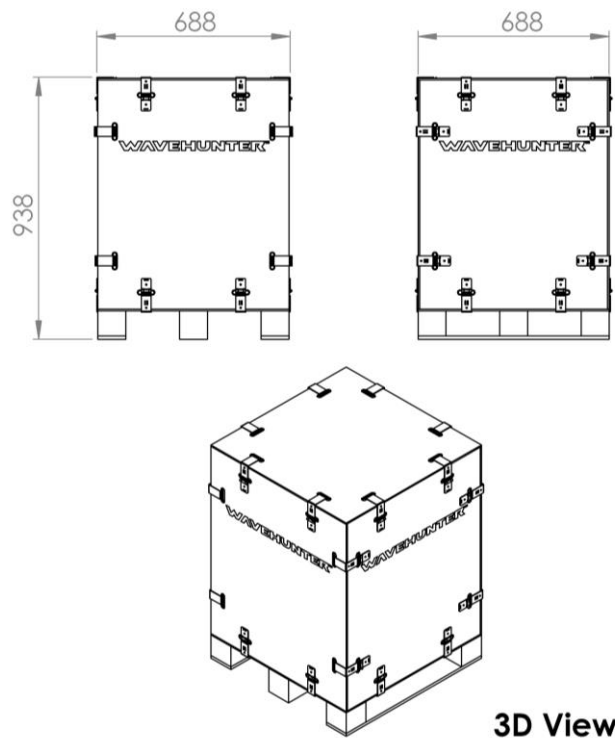

Additional Accessories

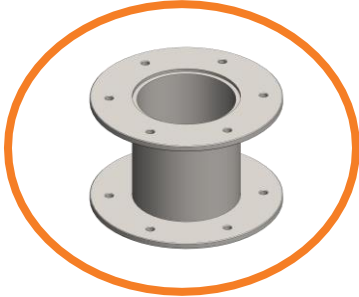

A-BRKT-063-V1-01 (Optional)

Wave Hunter Aluminium Base (Pedestal)



Various fly leads/pigtails available (Optional)

- A-CAB-163: 0.75m RG141 SMA Male - SMA Male
- A-CAB-164: 0.75m RG141 SMA Male - RPSMA Male

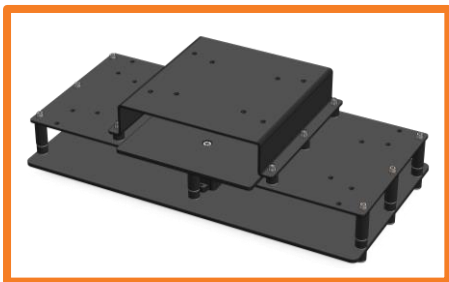

A-BRKT-064-V1-02 (Optional)

3 Celerway Arcus Routers Mounting Bracket, With Router Plate and Dampers

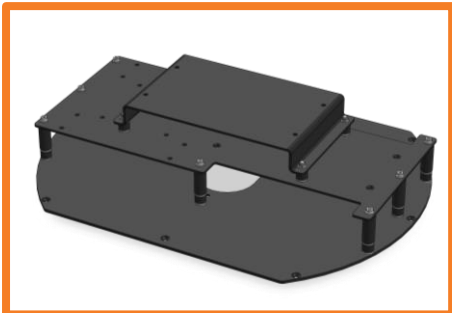

A-BRKT-067-V1-01 (Optional)

Celerway Stratus and Arcus Mounting Bracket

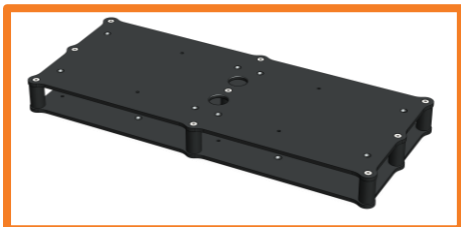

A-BRKT-068-V1-01 (Optional)

3-Peplink BR2 Pro Mounting Bracket

CONTACT POYNTING

Poynting Antennas (Pty) Ltd - Head Office

Unit 4, N1 Industrial Park,
Landmarks Avenue,
Samrand, 0157, South Africa

Phone: +27 (0) 12 657 0050

E-mail: info@poynting.tech

International Email: sales-global@poynting.tech

Poynting Europe

Regus Business Center Neue Messe Riem
Kronstadter Straße 4
81677 München
Germany

Phone: +49 89 7453 9002

E-mail: sales-europe@poynting.tech

Poynting USA

1804 Owen Court, Suite 104,
Mansfield,
TX 76063
USA

Phone: +1 817 533-8130

E-mail: sales-us@poynting.tech